

brilliance in solar lighting

photinus

INSTALLATIONSANLEITUNG INSTALLATION INSTRUCTION V.1 | 2019

alara

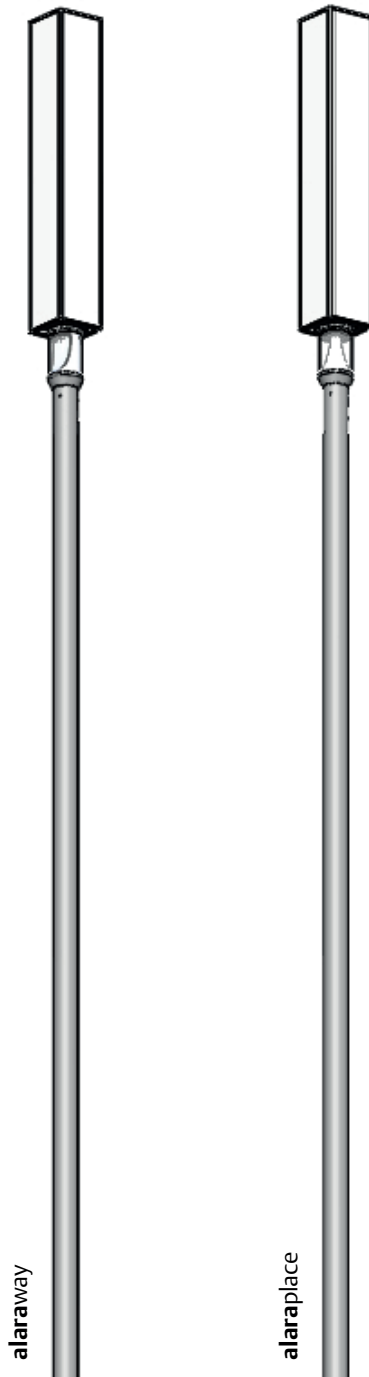

LIEFERUMFANG / INCLUDED PARTS

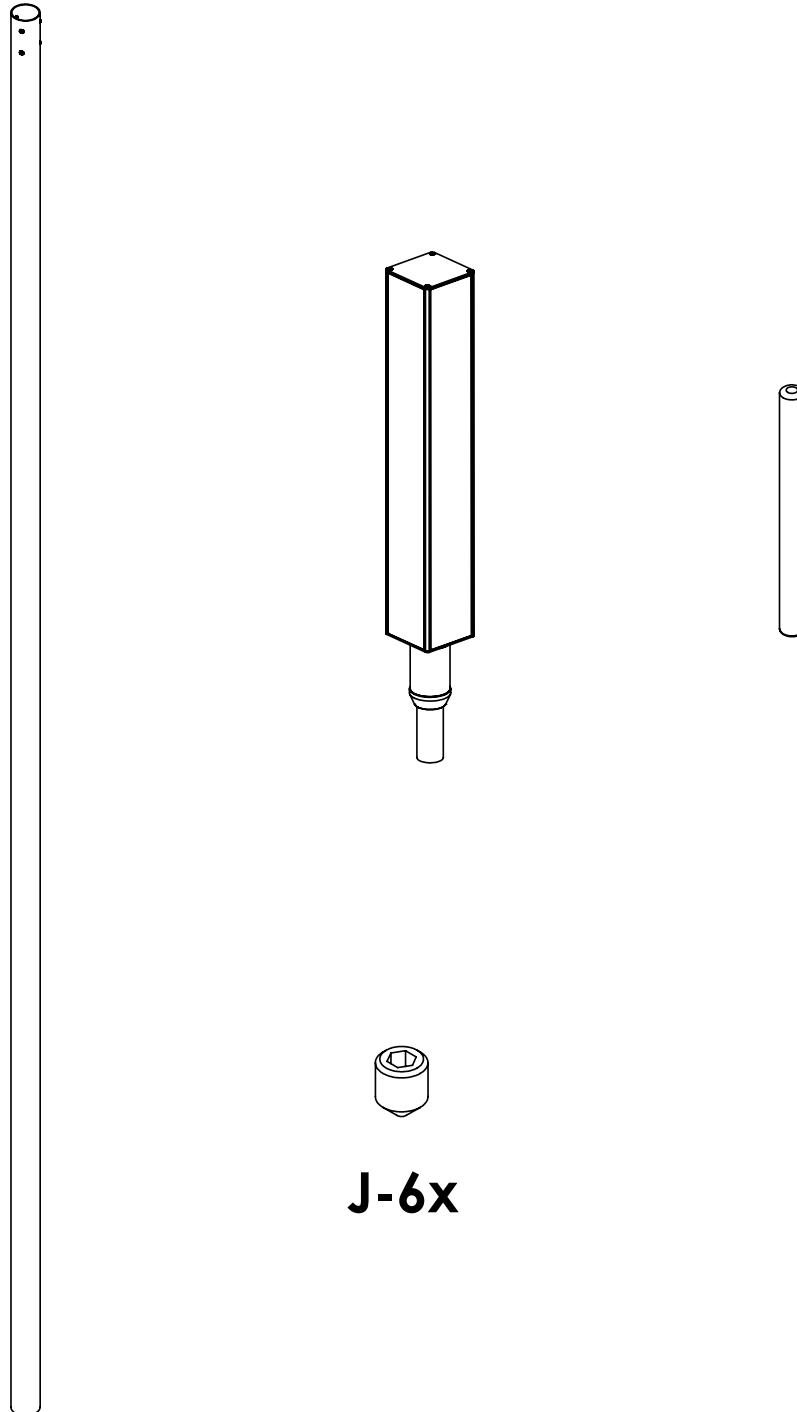

J-6x

BENÖTIGTES WERKZEUG IHRERSEITS / TOOLS REQUIRED

1 Inbusschlüssel / Allen Wrench **4**

AKKU UND LICHTMAST / BATTERY AND POLE

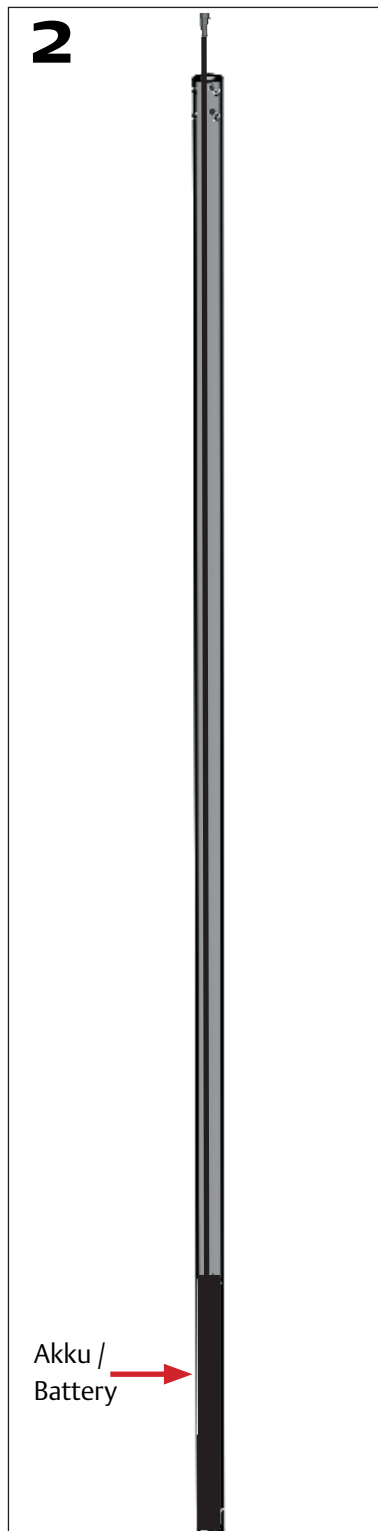
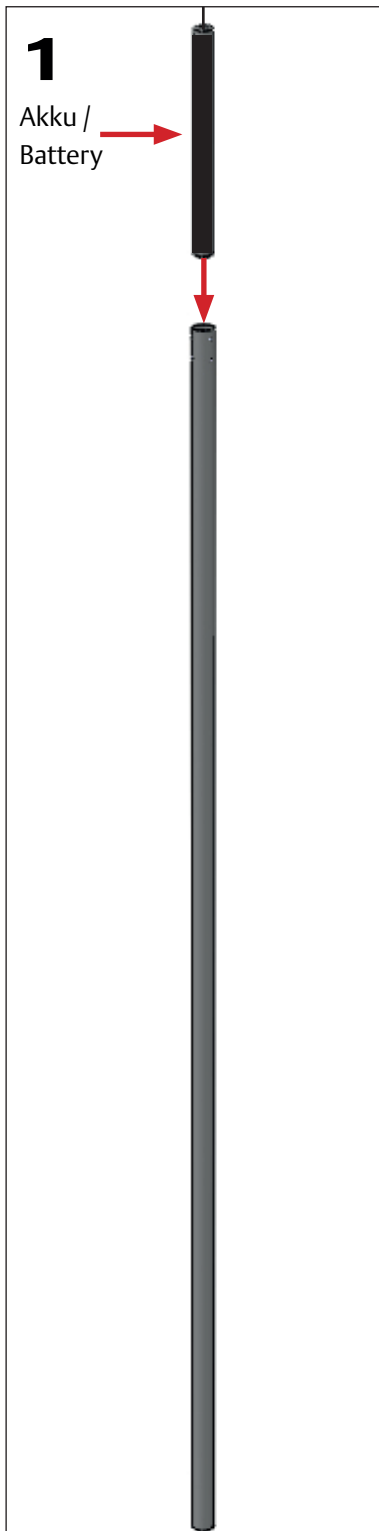

PHOTOVOLTAIK MODUL / PHOTOVOLTAIC MODULE

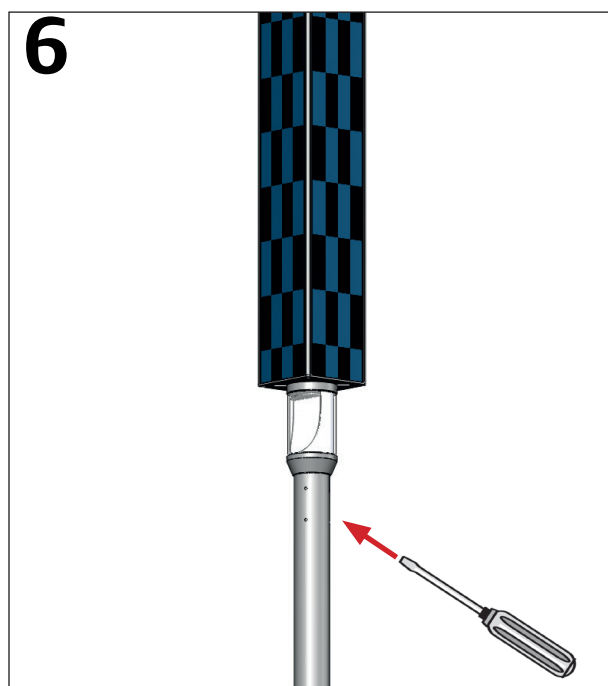
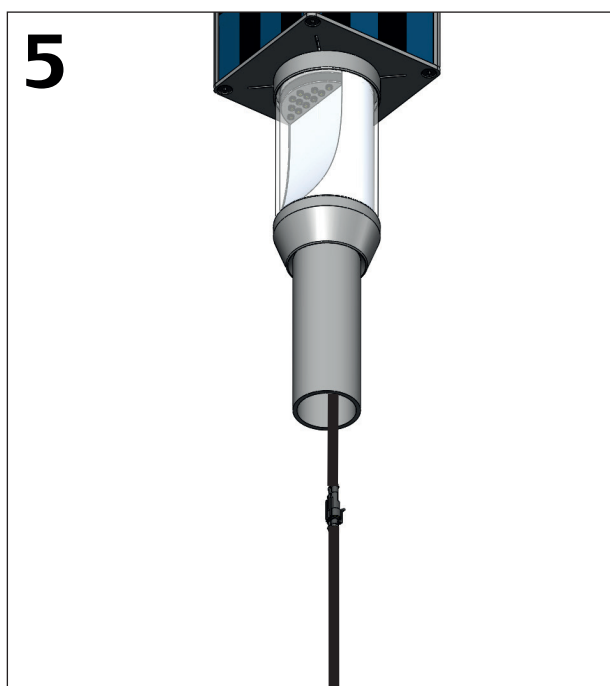
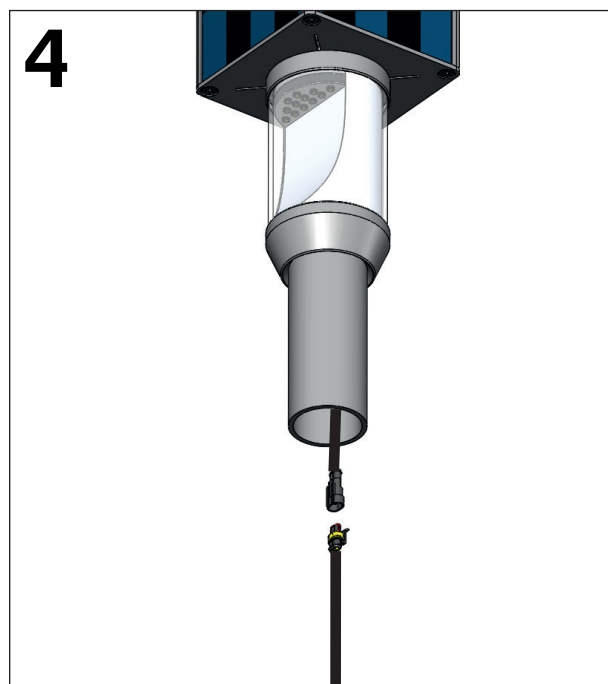
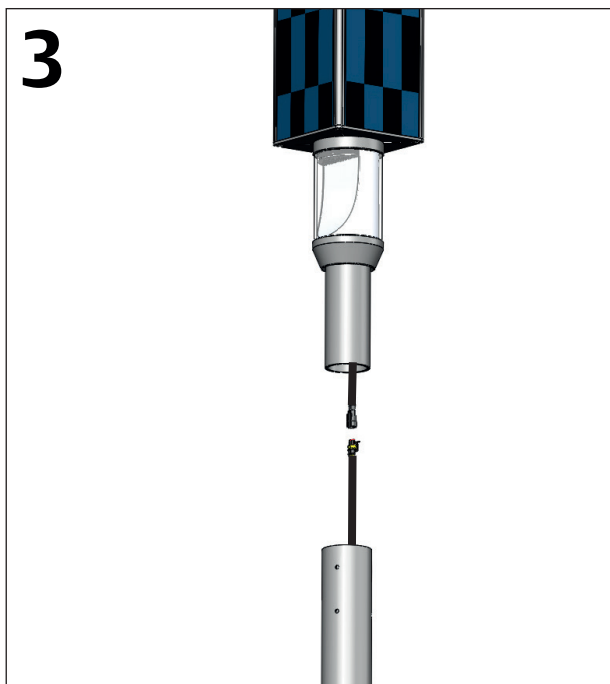

MONTAGEMÖGLICHKEIT 1 - ROHRFUNDAMENT

MOUNTING POSSIBILITY 1 - PIPE FOUNDATION

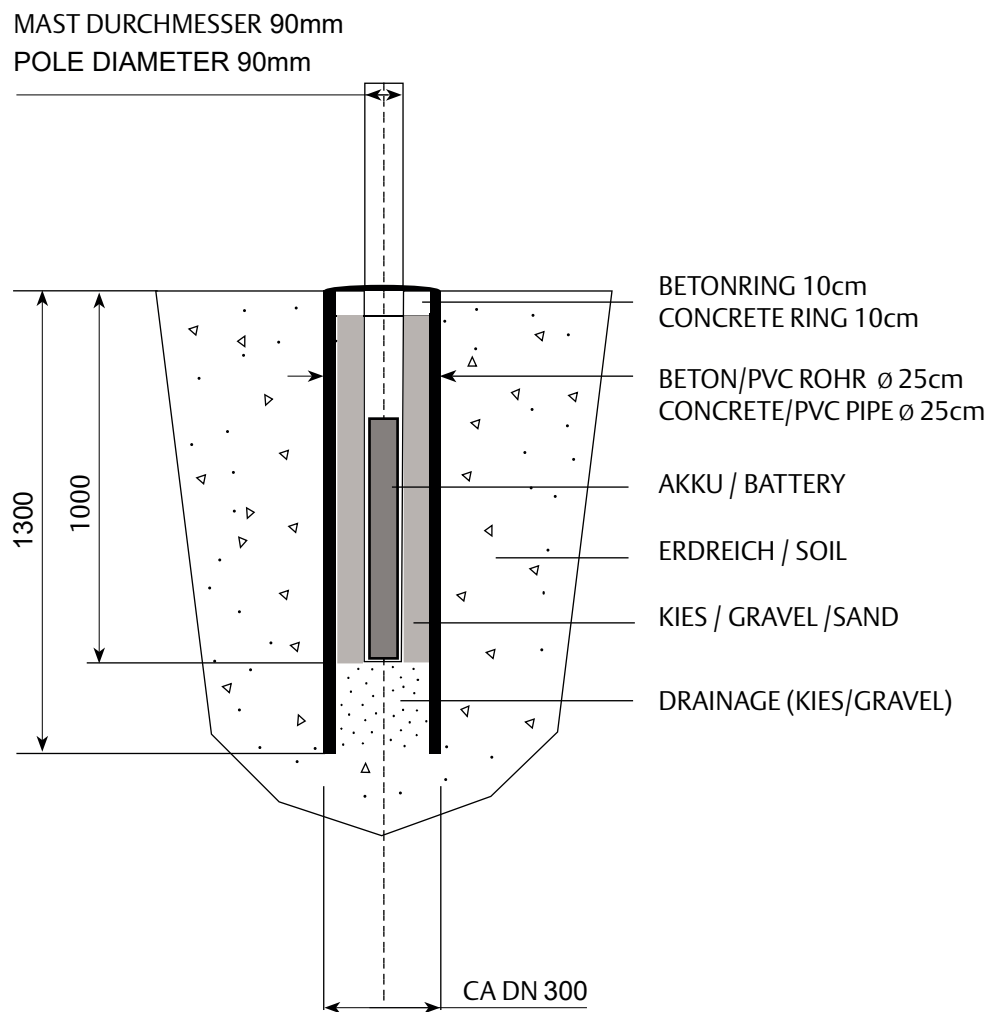

MONTAGEMÖGLICHKEIT 2 - SCHRAUBFUNDAMENT

MOUNTING POSSIBILITY 2 - GROUND SCREW FOUNDATION

KRINNER Screw Foundation

Art. 26160: KSF E140x1600-E76-100

Art. 26813: Exzentrersatz - E90

MAST DURCHMESSER 90 mm
POLE DIAMETER 90 mm

