

Datasheet

merkur150 / merkur150 Duo



merkur150



**GERMAN
DESIGN
AWARD
WINNER
2019**

SELF-SUFFICIENT SOLAR LED STREET LAMP

APPLICATION

The merkur150 stands out for its exceptional, cubic and modern design and guarantees a secure supply in all different climate zones. The merkur150 solar light is a solar powered LED street lamp, which is used in regions without electrical infrastructure or in which it would not be economically feasible to implement one. The luminaire is especially used in areas that demand a secure supply and excellent light quality even in dim conditions.

The merkur150 is able to generate sufficient energy via the diffuse light component in regions with poor weather (snow, fog, etc.) due to the cubic aluminium construction with 4 photonus high performance photovoltaic modules. The vertically arranged modules prevent snow from accumulating on it in winter. A sophisticated energy management system guarantees secure functionality over several nights even in poor weather conditions. The merkur150 is best suited for residential streets, side streets, cycle routes and footpaths as well as car parks etc. in accordance with DIN EN13201 due to its light output.

OPERATION

The integrated battery is loaded via 4 photonus high performance photovoltaic modules and powers efficiently the LED array during the night.

OPTIONS

Anthracite is our standard colour for the merkur150. Nevertheless, the luminaire can be ordered in all RAL colours for large projects and at an additional charge.

GUARANTEE

5 years

The warranty of the solar illumination is provided, as far as the illumination is installed like described in the installation instructions. The warranty is void, if the product settings haven't been changed by photonus authorized employees/partners and/or using non-photonus approved tools.

SOLAR LIGHT		merkur150 / merkur150 Duo
SOLAR MODULES		
Solar modules	Monocrystalline silicon cells with exceptional efficiency specially processed by photinus.	
Efficiency	20%	
Max. performance of the energy column Pmpp	150 Wp / 4 solar modules, they are also charged up in cloudy conditions.	
BATTERY IN THE POLE		
Battery	LiFeP04 / 461 Wh (12,8 V 36Ah)	
Operating temperature	-20°C to +60°C	
Life of battery	up to 10 years	
Protection class	IPX8	
LIGHTS		
Max. luminous flux	Depending on the location where the light is staying. Location: Luminous flux / autonomy time / normal mode / smart mode 52. degrees lat. (Amsterdam): 5 W, 1000 lm / V5 / 8 days / 12 days 47. degrees lat. (Munich): 9 W, 1400 lm / V5 / 6 days / 9 days 40. degrees lat. (Madrid): 22 W, 3790 lm / V5 / 3 days / 5 days	
Max. Efficiency	200lm/W at 600mAh	
LED module / max. watts	100 W	
Colour temperature	4000K (By request changeable: Amber Light, 2000K, 3000K, 5000K)	
Life of LED	>75 000 h (L80)	
Protection class	IP 67	
MATERIALS		
Pole	galvanised and powder-coated steel „Sparkling iron effect dark“	
Metal parts	powder-coated aluminium „Sparkling iron effect dark“	

Technical changes reserved!

DIMENSIONS	
Total height from ground level	4930 mm
Height of light from ground level	4800 mm
Height of vandalism protection	3300 mm
Height of energy column	1500 mm
Total length of pole	6000 mm
Material pole	galvanised steel „Sparkling iron effect dark“
Length of pole under ground	1100 mm
Total weight of solar light	110 kg
Wind load	Wind zone 4, with 30m / s (110km / h), (Lloyds CLAME 2016)

Salt spray test (ISO 9227:2012)

Corrosion test in artificial atmosphere - salt spray test (ISO 9227:2012)

All solar lights have successfully passed the salt spray test.

Details



Dimensions

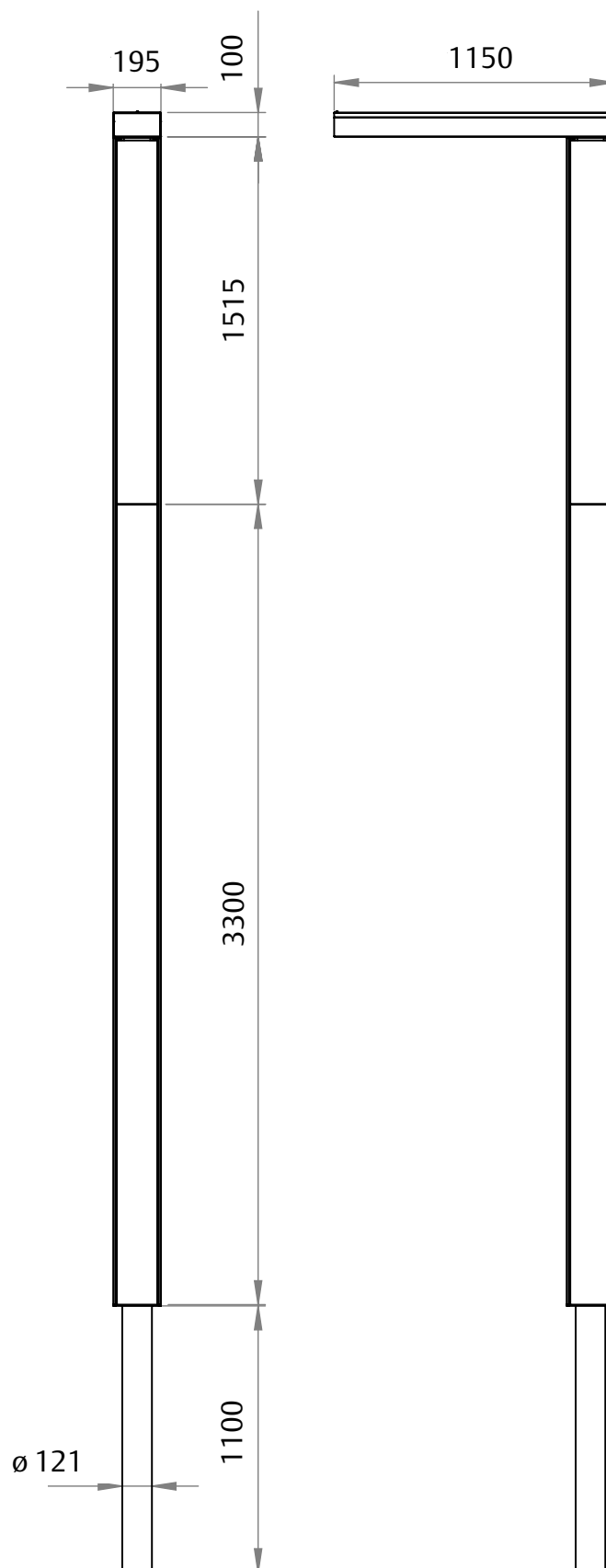

photinus OPTIC

Standard optic with optimum compromise between illumination width and illumination depth

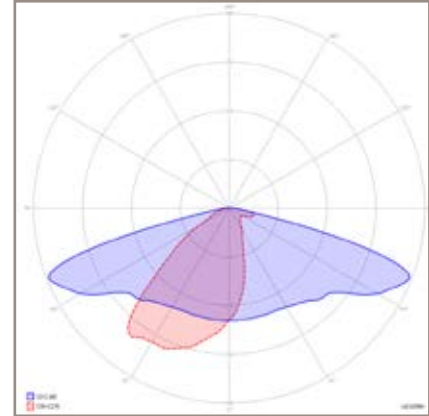
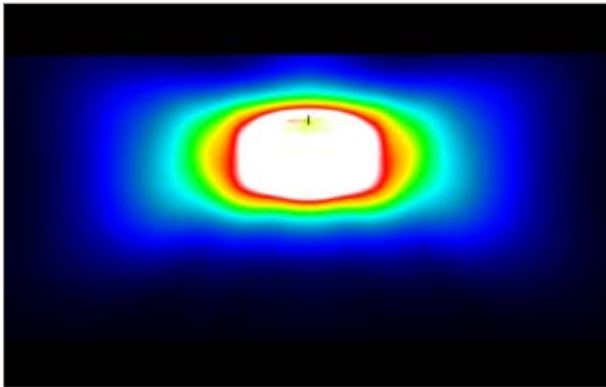

SCL OPTIC

Optimal for streets with a width from 2m to 4m (cycle paths, walkways and small streets)

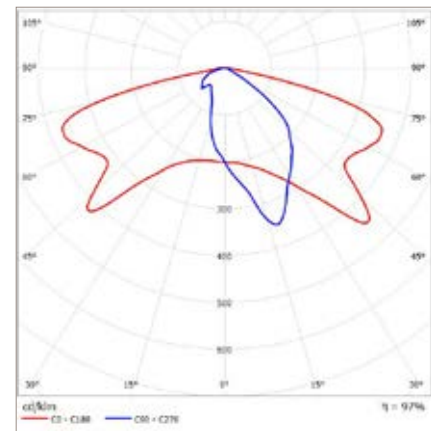
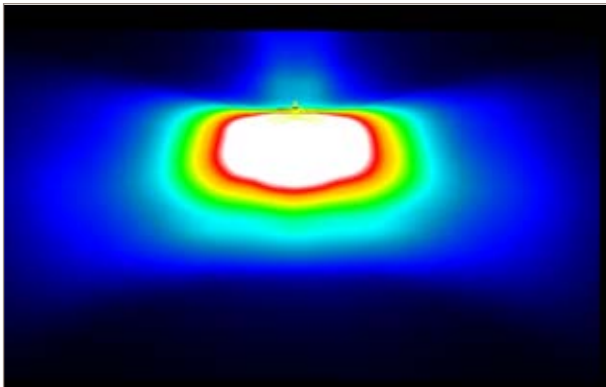

DWC OPTIC

Optimal for streets with a width from 4m to 7m (residential roads, secondary roads and main roads, depending on location)

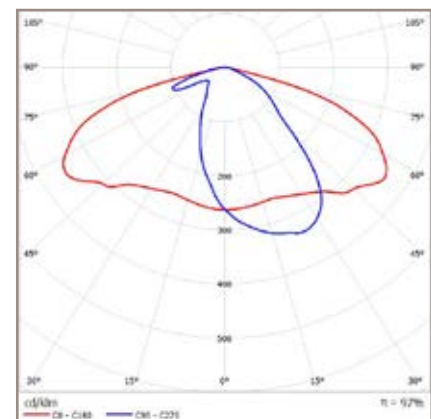
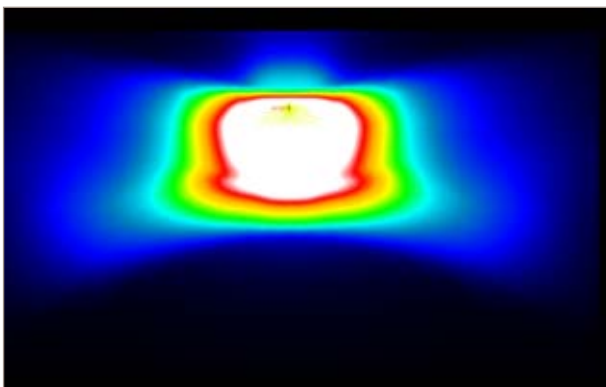

ENERGY AND TIME MANAGEMENT

Standard factory setting V5

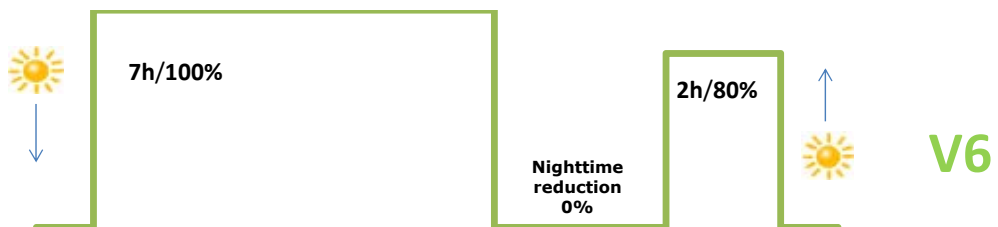
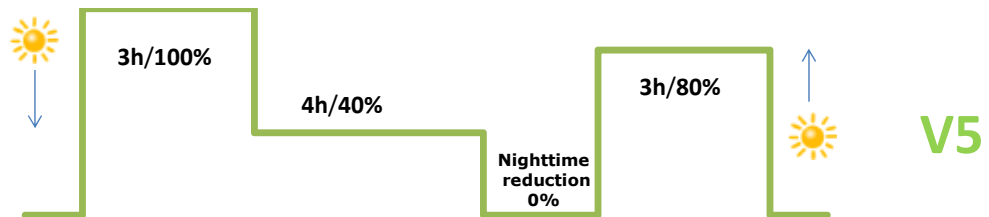
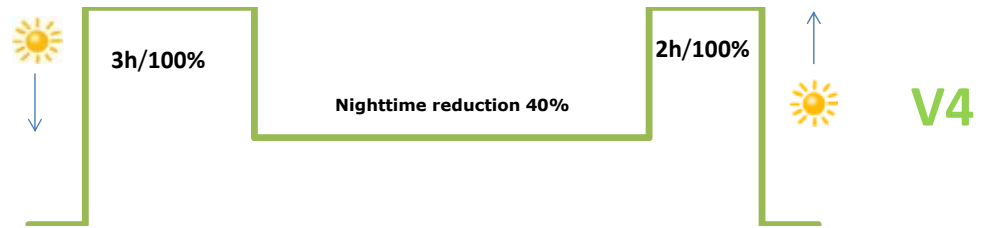
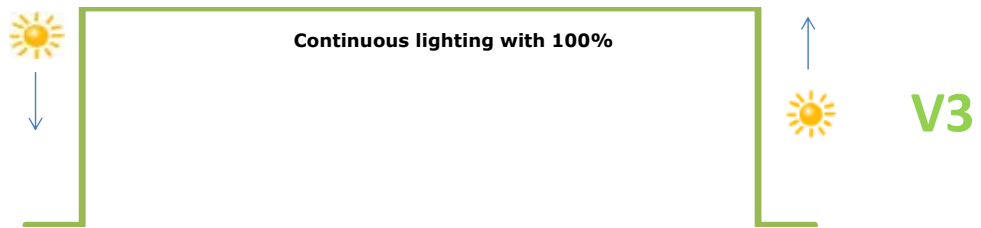

PIPE FOUNDATION

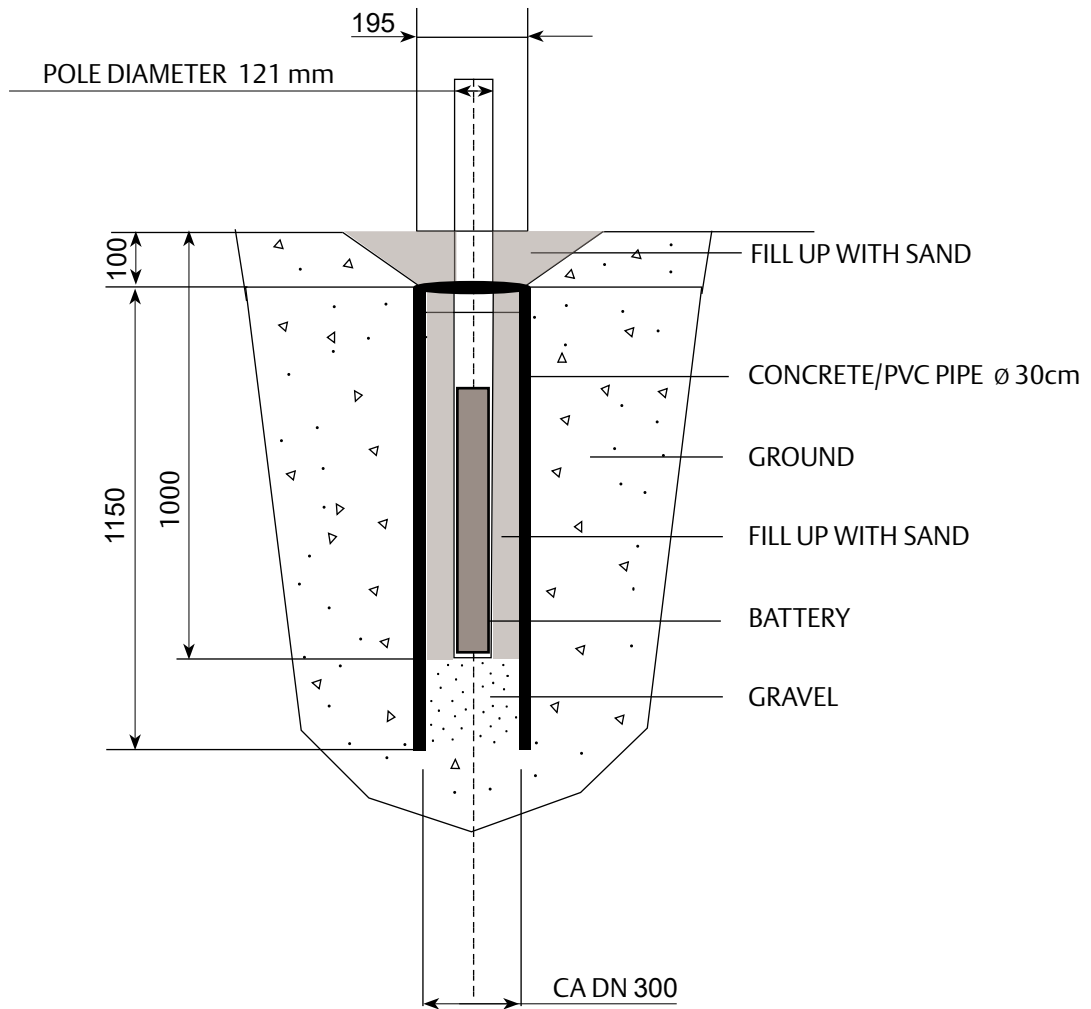

References

merkur
Sidewalk Hausham / DE



merkur
Holmenkollen / NOR

merkur
Neighborhood Adliya / BHR



References



merkur
Cycle- walkway / PL

merkur
Neuschwanstein / DE



merkur
Eching / DE